

# FAILURE ANALYSIS GEARS-SHAFTS-BEARINGS-SEALS

**CONTENTS**

	Page
Part 1 Introduction.....	1
Part 2 Gear Distress and Failure Modes .....	2
Surface Fatigue – Pitting .....	3
– Spalling .....	5
Wear .....	6
– Degrees of Wear .....	7
– Types of Wear .....	8
– Miscellaneous Wear Modes .....	9
Plastic Flow .....	10
Breakage .....	11
Failure Associated with Processing .....	13
Part 3 Shaft Distress and Failure Modes .....	14
Part 4 Anti-Friction Bearing Failures .....	16
Part 5 Failure of Contact Oil Seals .....	18

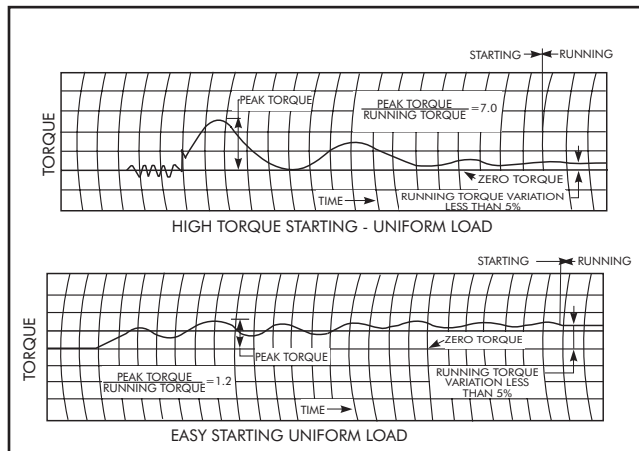
**1 - INTRODUCTION**

The function of the industrial power transmission gear drive is to reliably transmit torque and rotary motion between a prime mover and a driven piece of equipment at acceptable levels of noise, vibration and temperature. When one or more of the preceding operating characteristics exceeds allowable limits, the drive and its application should be examined to determine the cause of the problem. Gear drive components most commonly subject to distress are the gears, shafts, bearings and seals. The purpose of this paper is to describe a number of distress and failure modes of each of these components and to indicate probable causes and possible remedies for these failure modes.

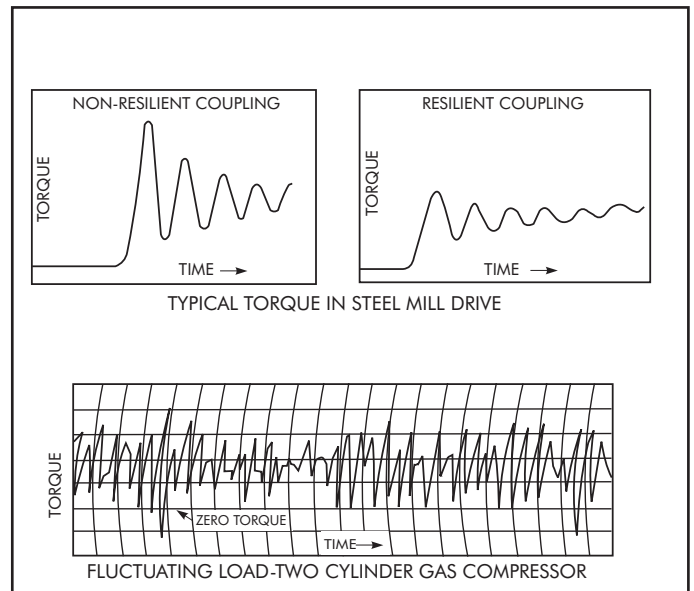
For drives that are properly designed and manufactured, abnormal distress or failure can result from misapplication or poor installation or poor maintenance.

Continuous steady state overloads can result from erroneous initial power requirement calculations, over motoring, increased output demands, etc. Such loading should be detectable by motor overheating or from electrical meter readings on the driving motor.

Momentary or transient peak loads are of such short duration that electrical meters do not respond accurately to them. In such cases torquemeter readings of instantaneous loads, as shown in **Figure 1.1** may be necessary to determine actual torque loads.



**FIG. 1.1 (253-2) TORQUE METER RECORD**



**FIG. 1.2 (253-1) TORQUE METER RECORD**

Vibratory loads, or system dynamic loads depend on the interrelation of the components in the entire system with one another and torque readings or a study of the system is required to assess instantaneous loads. From properly obtained torque readings, see **Figure 1.2**, the load characteristics of the system can be determined including steady state loads, peak loads, accelerating loads, reversing and vibratory loads and other dynamic effects that may exist. Once the nature of the load within a system has been established, the manner in which the load affects each of the drive components must then be assessed.

Unexpected environmental conditions affecting gear drive performance can be grouped into three categories:

- 1 – ambient temperature, either high or low
- 2 – airborne abrasive material
- 3 – corrosive materials of gaseous, liquid or solid form

Ambient temperatures that are too high may result in lube temperatures so high that ineffective oil films are formed, while too low a temperature may thicken oil so much that flow is restricted and certain parts may be starved of lubricant. In either case, abnormal wear may result. Ingress of airborne abrasive material can cause premature bearing failure, abnormal gear wear and can damage shaft journals for oil seals. Infiltration of corrosive gases, liquids (including water) or solids can result in corrosive chemical reactions on bearing, gear and seal contact surfaces that can cause premature failure or abnormally high wear rates.

Last but not least, installation, care and maintenance procedures can influence gear drive performance. Units improperly installed or maintained can result in such things as poor tooth contact, preloaded bearings, damaged bearings and improper or poor lubrication and lubrication leakage.

A gear drive is one part of a power system which has certain load characteristics peculiar to the specific application. The gear drive package itself is a subsystem within the overall system and in addition to transmitting the load demands of the overall system, it is subject to additional load variations generated or contained within itself.

The elastic deflection of the gears, shafts, bearings and their supporting structures determine to a large degree the manner in which mating gears will be aligned to one another under operating loads. These deflections along with manufacturing

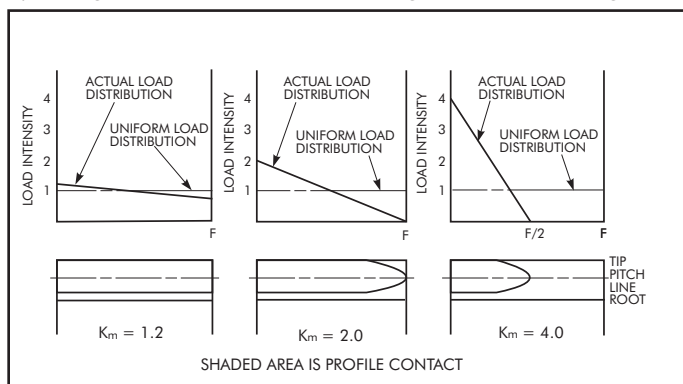


FIG. 1.3 (253-3) CONTACT PATTERNS AND LOAD DISTRIBUTION

tolerances result in loads being non-uniformly distributed across the gear tooth surface, thus stressing some areas of the tooth more highly than others. In the AGMA rating formulas, which are in wide use today, this effect is recognized by the incorporation of a load distribution factor, designated  $C_m$  or  $K_m$ . The numerical value of this factor is the ratio of the maximum load intensity on the tooth to the load intensity for a uniformly distributed load. **Figure 1.3** shows several contact patterns that might be observed on loaded teeth. Load intensity diagrams along with values of load distribution factors are shown for each case. Other more complex intensity distributions often prevail, but for most well designed gear sets, the load distribution factors vary from 1.2 to 1.7.

The AGMA rating formulas also recognize a tooth loading effect which is velocity dependent, but is largely independent of the system transmitted load. It is the dynamic impact loading a tooth encounters as it picks up its share of the load as it enters the zone of tooth action at the mesh. The AGMA formulas account for the usual accuracies of today's manufacturer, but if exaggerated errors are present, from whatever cause, dynamic loads can be a source of tooth surface distress or tooth fracture.

## 2 — GEAR DISTRESS AND FAILURE MODES

Distress or failure of gears may be classified into four categories:

- 1 – surface fatigue (pitting),
- 2 – wear,
- 3 – plastic flow
- 4 – breakage.

The appearance of the various distress and failure modes can differ between gears that have through hardened teeth and those that have surface hardened teeth. These differences result from the different physical characteristics and properties and from the residual stress characteristics associated with the surface hardened gearing. Where appropriate, examples of distress of both through and surface hardened gears are shown and discussed.

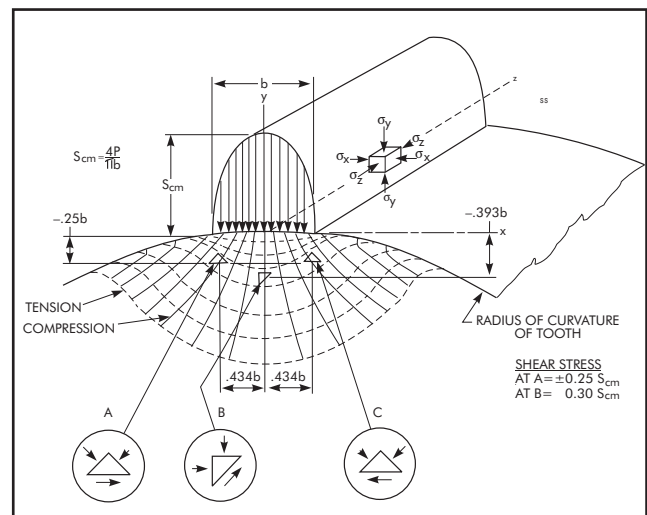


FIG. 2.1 (312-10) HERTZIAN STRESSES

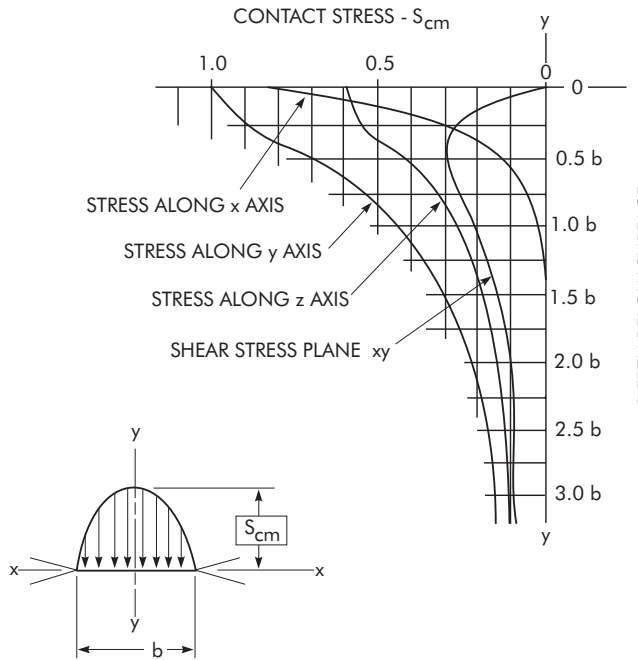


FIG. 2.2 (312-6) VARIATION OF STRESS BELOW SURFACE

**SURFACE FATIGUE**

Surface fatigue is the failure of a material as a result of repeated surface or sub-surface stresses beyond the endurance limit of the material. **Figure 2.1** indicates the theoretical mutual Hertzian stresses occurring when a gear and pinion mesh. There are compressive stresses at the surface and unidirectional and bi-directional sub-surface shear stresses. **Figure 2.2** indicates the magnitude of these stresses.

**PITTING**

Pitting is a form of surface fatigue which may occur soon after operation begins and may be of three types:

- 1 - initial (corrective)
- 2 - destructive
- 3 - normal

INITIAL PITTING is caused by local areas of high stress due to uneven surfaces on the gear tooth. This type pitting can develop within a relatively short time, reach a maximum and with continued service polish to a lesser severity. Initial pitting shown in **Figure 2.3** usually occurs in a narrow band at the pitchline or just slightly below the pitchline. It is most prominent with through-hardened gears and is sometimes seen with surface-hardened gears.

The shape of a classical pit is shown in **Figure 2.4**. It appears as an arrowhead pointing in the direction of on coming contact. Starting at the surface of the tip of the arrowhead, the fracture proceeded inward at a shallow angle to the surface. Simultaneously, the crack broadened forming the arrowhead. The back side of the pit has a steep side. The magnified pit shown in **Figure 2.4** is shown with the remaining portions of the tooth in **Figure 2.5**. Although there were several large pits on the tooth surface, this pitting was corrective since it progressed no further with continued operation.

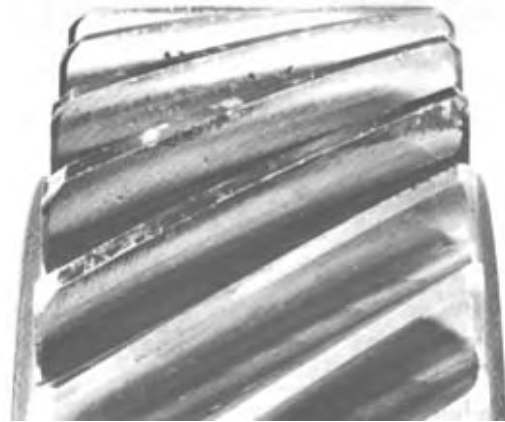


FIG. 2.3 (683-2) INITIAL (CORRECTIVE) PITTING



FIG. 2.4 (683-9) INITIAL (CORRECTIVE) PITTING ENLARGED PHOTO

For most through-hardened industrial type gears, initial pitting is considered normal and no remedial action is required. Where necessary, initial pitting can be reduced by special tooth finishing means and sometime by a careful break-in at reduced loads and speeds. In some special critical applications, teeth are copper or silver plated to prevent or reduce initial pitting.

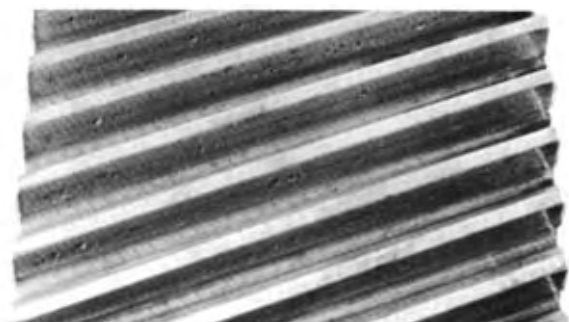


FIG. 2.5 (697-4) INITIAL (CORRECTIVE) PITTING

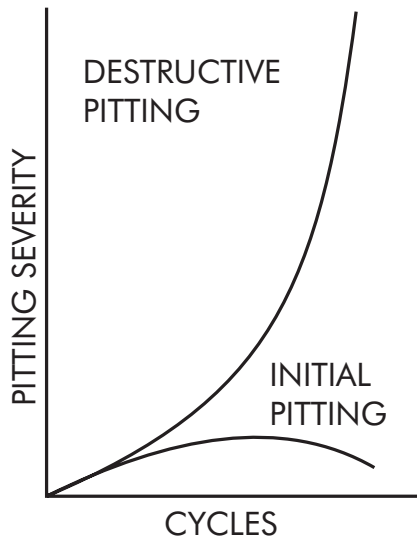


FIG. 2.6 (2342-1C) PITTING SEVERITY

DESTRUCTIVE OR PROGRESSIVE PITTING on the other hand usually starts below the pitch line, in the dedendum portion of the tooth and progressively increases in both the size and number of pits until the surface is destroyed. Destructive pitting can appear to be as severe as corrective pitting at the beginning of operation, however, as time goes on the severity of destructive pitting sharply increases and far surpasses the severity of corrective pitting as shown in **Figure 2.6**. **Figure 2.7** illustrates this type pitting on a through-hardened gear. **Figure 2.8** shows destructive pitting of a surface hardened gear.

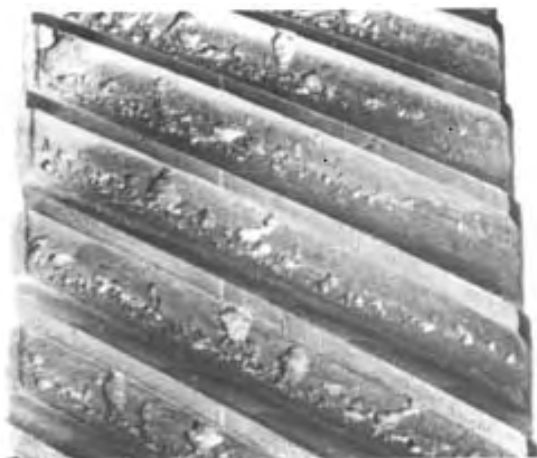


FIG. 2.7 (828-1) DESTRUCTIVE (PROGRESSIVE) PITTING THRU HARDENED GEARS



FIG. 2.8 (2342-2C) DESTRUCTIVE (PROGRESSIVE) PITTING



Destructive pitting usually results from surface overload conditions that are not alleviated by initial pitting. If tooth surface hardness is within specified values, system overloads are usually the cause of such pitting. To see a finely pitted gear, with several large pits is no cause for alarm since it can be of a corrective nature, see **Figure 2.9**.

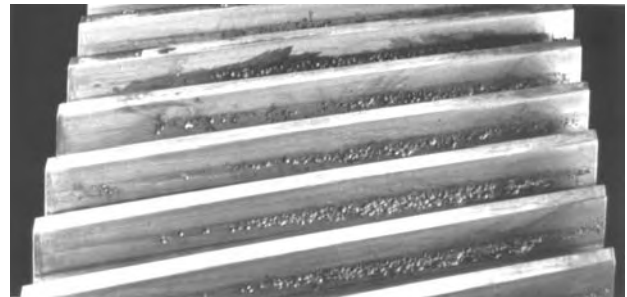


FIG. 2.10 (2342-4C) NORMAL DEDENDUM WEAR

NORMAL DEDENDUM PITTING (DEDENDUM WEAR) of fully loaded through-hardened gears manifests itself as small or modest size pits, covering the entire dedendum portion of the tooth flanks. Continued operation results in pit rims being worn away with virtually no further pitting occurring. **Figure 2.10** shows the tooth appearance in the pitting phase, prior to pit rim wear. **Figure 2.11** illustrates a dedendum pitted gear tooth after pit rims have been worn away.

Dedendum pitting results when loads are at or close to maximum allowable surface loading values. The dedendums are most vulnerable to this phenomenon because of the preferential orientation of the surface microcracks along the tooth profile. **Figure 2.12** illustrates this. The orientation of the cracks in the dedendum of both pinion and gear are such that oil is





FIG. 2.11 (683-i6) NORMAL DEDENDUM WEAR

readily trapped in them as the contact rolls over the surface openings. These then propagate rapidly into pits by hydraulic pressure. In the addendum, the oil is forced out of the microcracks before the contact progresses far enough to seal the surface openings off, hence hydraulic propagations of the crack is almost nil and few pits are formed in this region.

At loadings currently used for industrial surface hardened gears, pitting is much less prevalent than with through-hardened gears. When it does occur, the appearance may be similar to that of through-hardened gears, but it often looks different.

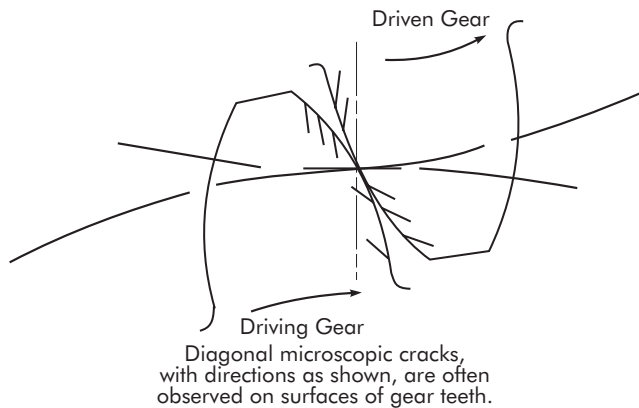


FIG. 2.12 (2342-5C) TOOTH SURFACE MICROCRACKS

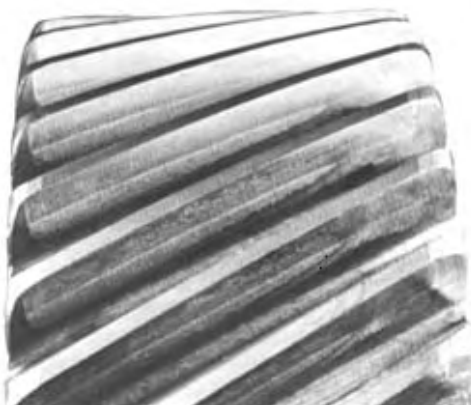


FIG. 2.13 (683-12) MICRO-PITTING (FROSTING)

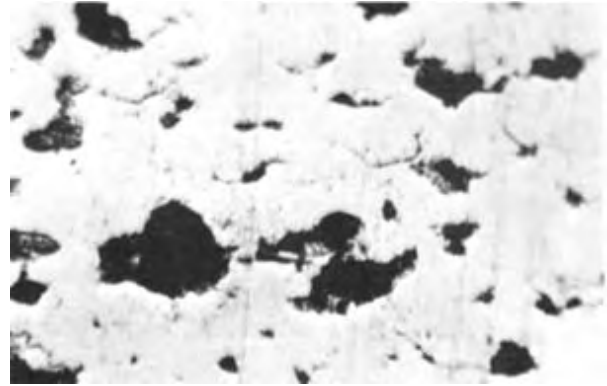


FIG. 2.14 (2342-6C) MICRO-PITTING (ENLARGED PHOTO)

MICRO-PITTING (FROSTING). **Figure 2.13** shows a micro-pitted carburized tooth as it appears to the naked eye and **Figure 2.14** shows the surface and micro-pitting enlarged 430 times. This type of pitting is considered to be normal.

**SPALLING**

SPALLING is a term used to describe a large or massive area where surface material has broken away from the tooth. In through-hardened and softer material, it appears to be a massing of many overlapping or interconnected large pits in one locality. See **Figures 2.15** and **2.16**. In surface hardened material it manifests itself as the loss of a single or several large areas of material. The visual pit like attributes are not observed, see **Figure 2.17**. Frequently the bottom of the spall appears to run along the case-core interface.



FIG. 2.15 (13-162) SPALLING (THRU HARDENED GEAR)

Spalling is caused by high contact stresses possibly associated with proud areas of the tooth surface. With surface-hardened gear teeth, surface or subsurface defects or excessive internal stresses from improper heat treatment also can cause spalling.

CASE CRUSHING is another form of spalling associated with heavily loaded case-hardened gears. It appears as long longitudinal cracks on the tooth surface which may subsequently break away. It often occurs suddenly, without



FIG. 2.16 (2342-7C) SPALLING (THRU HARDENED GEAR)

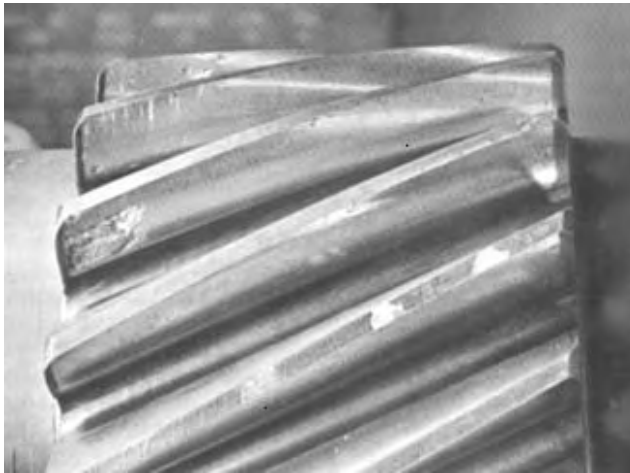


FIG. 2.17 (828-2) SPALLING (SURFACE HARDENED GEAR)

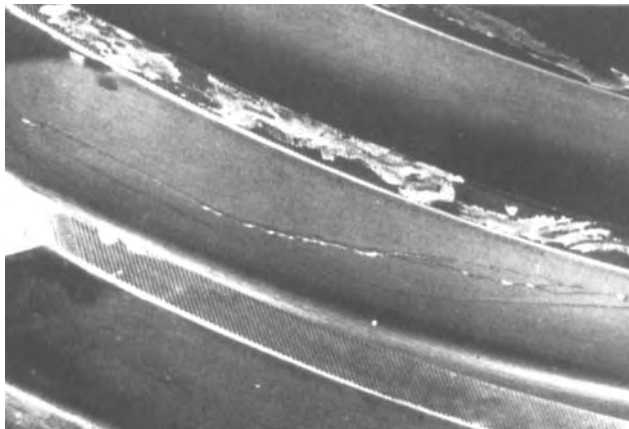


FIG. 2.18 (2342-8C) CASE CRUSHING

warning signs, on only one or two teeth of the pinion or gear. The cracks differ from those of pits in that they not only extend below the hard case, but most of its depth is in the softer core material. The cracks in the case, generally are perpendicular to the surface. Figure 2.18 shows an example of this failure mode. Failure may be due to insufficient case depth, insufficient core hardness or high residual stresses or too high loading.

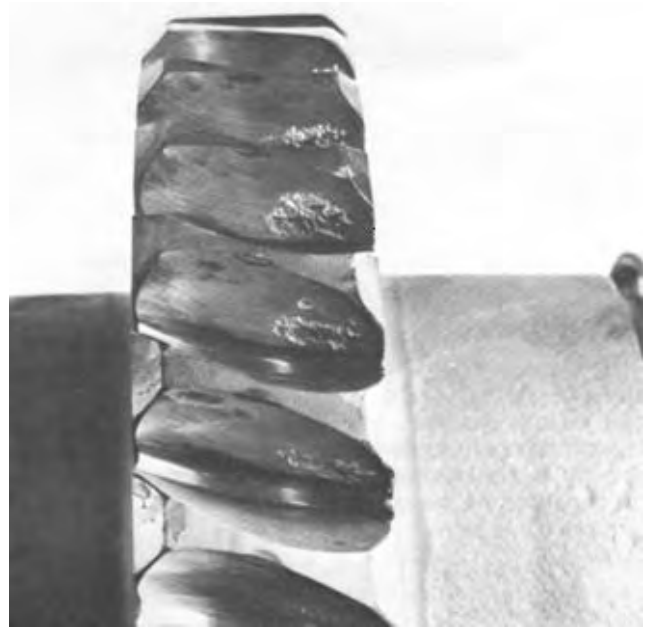


FIG. 2.19 (1169-16) WORM GEAR PITTING)

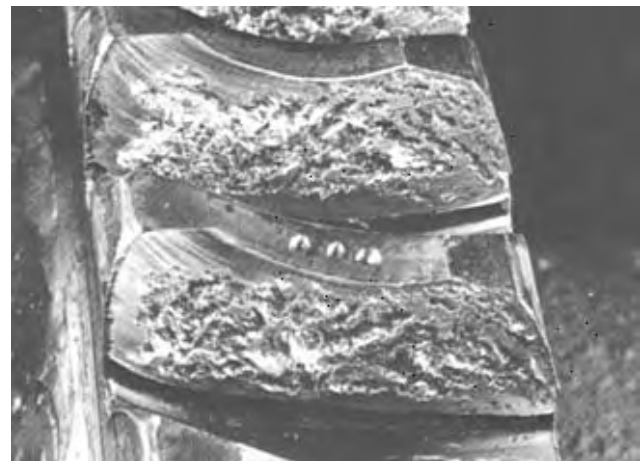


FIG. 2.20 (596-2) WORM GEAR PITTING)

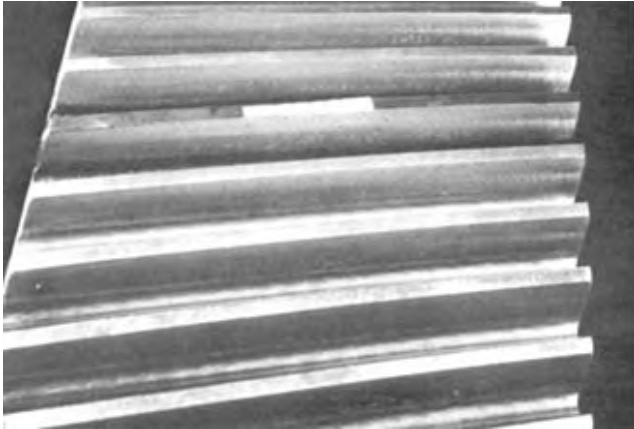
WORM GEAR endurance tests have been performed by Falk during the past several years. The tests have run to approximately 20,000 hours and from these tests varying degrees of surface destruction may be severe when compared with that of a helical gear, the worm gears nevertheless survived the test. From this experience we can conclude that worm wheels incurring this amount of destruction can still perform satisfactorily. **Figures 2.19 and 2.20** illustrate this surface deterioration.

## WEAR

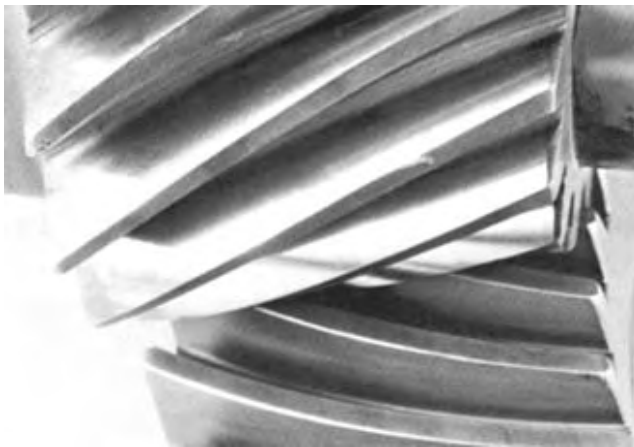
Wear is a general term describing loss of material from the contacting surface of a gear. There are varying degrees of wear, which can be measured in terms of thousandths of an inch, per million or 10 million contact cycles, ranging from light to moderate to excessive wear.

## DEGREES OF WEAR

POLISHING OR LIGHT WEAR, **Figures 2.21** and **2.22** is the slow loss of metal at a rate that will little affect satisfactory performance of the gears within the life of the gears. It is a normal, very slow wear-in process in which asperities of the contacting surfaces are gradually worn until very fine, smooth, conforming surfaces develop. Polishing or light wear can occur by either abrasive or adhesive mechanisms when thin oil films or what is known as boundary lubrication conditions prevail usually on slow speed applications.



**FIG. 2.21 (697-7) INITIAL PITTING AND LIGHT WEAR**



**FIG. 2.22 (2342-9C) POLISHING (SURFACE HARDENED GEAR)**

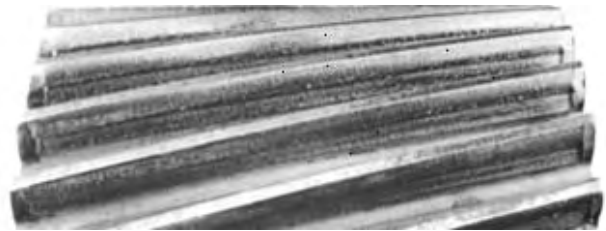
MODERATE WEAR, sometimes called normal wear, progresses at a rate slow enough that it will little affect satisfactory performance of the gears within their expected life. Tooth contact patterns indicate that metal has been removed from the entire tooth surface, but generally more from the dedendum areas. The operating pitch line begins to show as an unbroken line. Surface-hardened gears, because of their high surface hardness manifest less wear than do through-hardened gears.

The judgment of moderate wear is somewhat subjective because performance requirements and expectations vary over the broad spectrum of industrial gear drive applications.

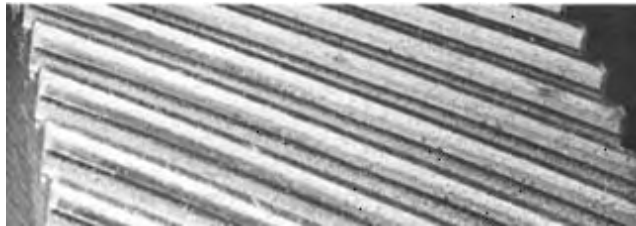
**Figure 2.23** illustrate wear observed on gears early in their operational history. Subsequently, these gears continued in operation to give years of additional satisfactory service.



1 YEAR ▲



1½ YEARS ▲

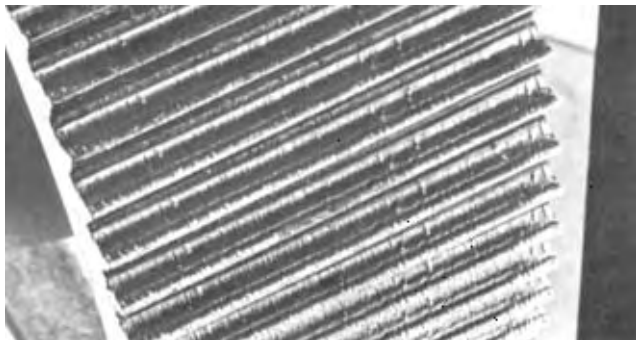


4 YEARS ▲

**FIG. 2.23 (697-10) TYPICAL TOOTH SURFACE APPEARANCE**

Moderate or normal wear depends on the lubrication regime, the nature of the load, the surface hardness and roughness, and on the contaminants present in the lubricating oil which might promote abrasive or corrosive wear. The limitations of usable oil viscosities and the speed requirements of the application often dictate that the gears must operate in the boundary lubrication regime where metal-to-metal contact occurs and wear takes place.

Moderate wear is normal and usually no remedial action is required other than normal maintenance of the lube system. If contaminants are present, filtering or more frequent lube changes are appropriate.



**FIG. 2.24 (747-1) EXCESSIVE WEAR**

EXCESSIVE OR DESTRUCTIVE WEAR, see **Figure 2.24**, is surface destruction that has changed the tooth shape to such an extent that smoothness of meshing action is impaired and life is appreciably shortened. Continued operation results in still greater wear and may eventually lead to tooth breakage.



The occurrence of such wear early in the operational history, can be caused by excessive loads, contaminated oil or too light an oil viscosity. Excessive wear incurred over a long period of operational history would be considered an advancement of normal wear from the moderate to the excessive degree and may not be detrimental to the operation of the gear drive.

**TYPES OF WEAR**

Wear types can be classified in two major categories:

- 1 - abrasive
- 2 - adhesive

ABRASIVE WEAR, sometimes called cutting wear occurs when hard particles slide and roll under pressure, across the tooth surface. Hard particle sources are: dirt in the housing, sand or scale from castings, metal wear particles from gear teeth or bearings, particles introduced into housing when filling with lube oil and particles infiltrating into unit in service. **Figure 2.25** shows abrasive wear of a through-hardened gear caused by massive loss of hard surface material from tapered bearing surfaces. Gear teeth surfaces hardened after cutting sometimes have rough surface that may wear softer mating teeth. **Figure 2.26** shows through hardened teeth that were worn away in just a few hours from the flame-hardened teeth which had rough surfaces due to a sand blast cleaning operation.

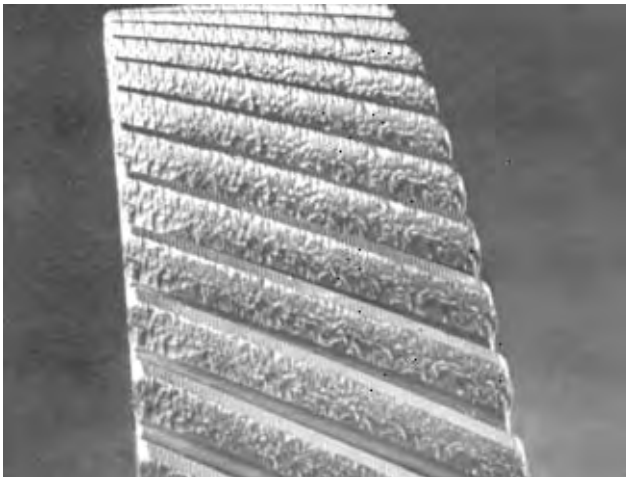
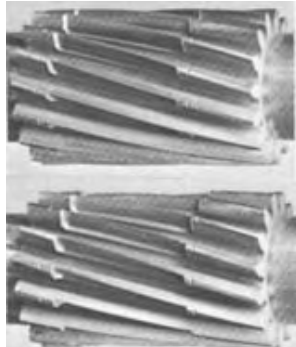


FIG. 2.25 (942-3) ABRASIVE WEAR (THRU HARDENED GEAR)

THRU HARDENED PINIONS(350-390 BHN  
RUN AGAINST FLAME HARDENED GEARS



GEAR SANDBLASTED  
5 HRS.  
.025 WEAR

GEAR SANDBLASTED  
50 HRS.  
.070 WEAR

FIG. 2.26 (749-1) ABRASIVE WEAR (THRU HARDENED GEAR)

SCRATCHING is a form of abrasive wear, characterized by short scratch-like lines in the direction of sliding. This type of damage is usually light and can be stopped by removing the contaminants that caused it. **See Figure 2.27.**

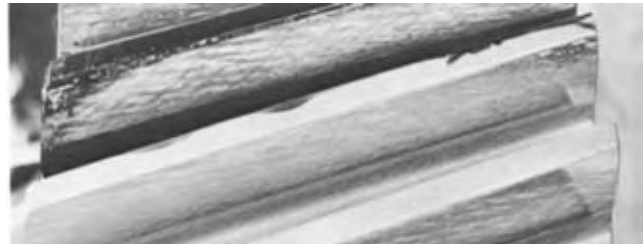


FIG. 2.27 (2342-10C) SCRATCHING

ADHESIVE WEAR results from high attractive forces of the atoms composing each of two contacting, sliding surfaces. Teeth contact at random asperities and a strong bond is formed. The junction area grows until a particle is transferred across the contact interface. In subsequent encounters, the transferred fragment fractures or fatigues away, forming a wear particle.

Adhesive wear depends upon the bond strength, which relates to the physical chemistry of the contact material and lubricant, on the load and on the material hardness. **Figures 2.28 and 2.29** show typical surfaces of through hardened and surface-hardened gears respectively that have undergone adhesive wear.

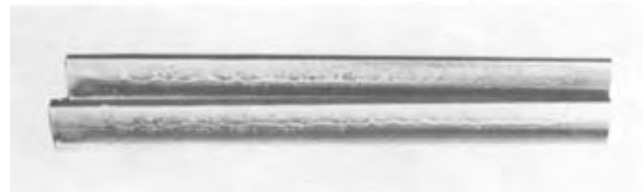


FIG. 2.28 (2342-11C) ADHESIVE WEAR (THRU HARDENED GEAR)

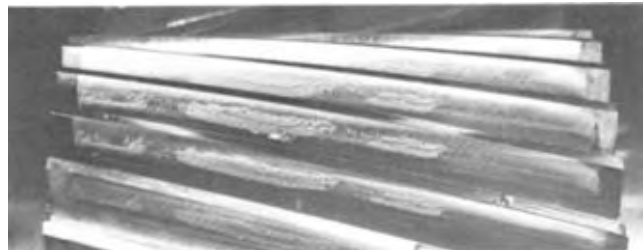


FIG. 2.29 (2342-12C) ADHESIVE WEAR (SURFACE HARDENED GEAR)

SCUFFING WEAR is the Falk term for an adhesive type wear occurring at normal temperatures where smooth burnished appearing radial striations are observed in the direction of sliding on the tooth surfaces. The texture of lower hardness through-hardened teeth is more coarse than that of higher hardness through hardened or surface-hardened teeth, see **Figures 2.28 and 2.29.** It can appear where tooth pressures are high and oil films are in the boundary regime and where speeds are slow enough that high contact temperatures do not occur. This type wear can be reduced by increased oil viscosities where applicable or by reduced load.



SCORING, **Figure 2.30**, is the smearing and rapid removal of material from the tooth surface resulting from the tearing out of small particles that become welded together as a result of oil film and high temperature metal-to-metal contact in the tooth mesh zone. After welding occurs, sliding forces tear the metal from the surface producing a minute cavity in one surface and a projection on the other. The wear initiates microscopically, however, it progresses rapidly.

Scoring is sometimes referred to as galling, seizing or scuffing. The term scoring is preferred.

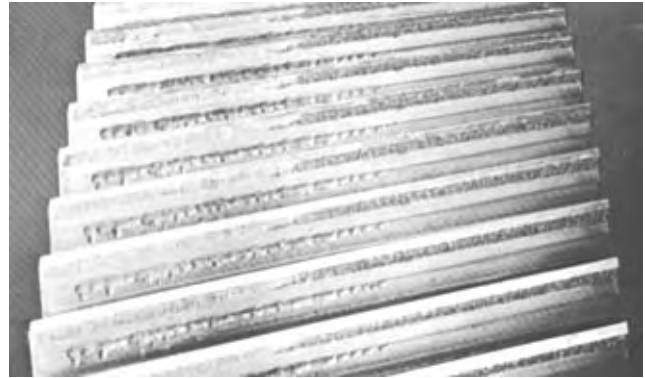
Scoring most frequently occurs in localized areas on the tooth where high contact pressure exists or at the tip or root where sliding velocities, and hence contact temperatures, are high. This mode of wear is usually associated with high pitch line velocities and is not common in the lower hardness through-hardened gears running at normal commercial speeds.

The direct causes of scoring are high contact temperature and pressure and marginal lubrication. Scoring can sometimes be prevented by use of more viscous oil or by an EP type oil. Localize high contact pressure can be relieved by improved finishing of tooth surfaces. Sometimes profile or face modifications are required on highly loaded teeth to minimize high localized pressures.

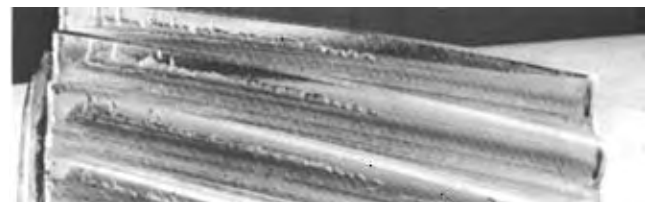


**FIG. 2.30 (683-1) SCORING**

WELDING is a hybrid form of scoring and pitting, where pit cracks are formed on the gear member with pit bodies subsequently adhering or welding to the pinion member. The two then run together with the profile formed by the original involute and the resultant pits bodies and pit cavities, see **Figure 2.31**. This phenomena is thought to occur at high load low speed and at marginal lubrication condition where high contact temperature prevail, but classical scoring doesn't occur. Increased oil viscosities or EP lubricants may help. Reduced loads will aid. Care must be exercised that axial displacement of the mating pinion and gear does not occur as high localized pressure can result from the mismatching of high and low profile spots which could cause fracture. If gearing is disassembled and reassembled, the tooth surfaces should be dressed to remove proud bumps.



**GEAR ▲**



**PINION ▲**

**FIG. 2.31 (683-13) WELDING (METAL TRANSFER GEAR TO PINION)**

**MISCELLANEOUS WEAR MODES**

WAVY TOOTH WEAR is occasionally observed on gears. Teeth can be observed to have wavy or undulating surfaces either by light reflection or by profile and lead checks. The crests and valleys of the waves usually lie parallel to the inclined lines of helical contact. See **Figure 2.32**. This wear pattern is thought to be caused by vibratory loads occurring in the system in which the gears are operating.



**FIG. 2.32(2342-13C) WAVY TOOTH WEAR**

SURFACE BUMPS are occasionally experienced as shown in **Figure 2.33**. The cause of such phenomena has not yet been defined. As with welding, axial movement could cause localized high tooth pressures which could fracture teeth. The tooth surfaces should be dressed to remove proud bumps.

WEAR PADS. Pinion elements of a gear set are frequently made slightly wider than the gear element. As wear occurs, unworn pads are left at the tooth ends of the pinion, **Figure 2.34**. These cause no problem as long as axial positioning of gears is properly maintained. If unit is disassembled for some reason and subsequently reassembled, these pads on the ends of the pinion should be ground flush to the worn surface to assure that heavy contact, and possible tooth fracture, does not occur from this source.

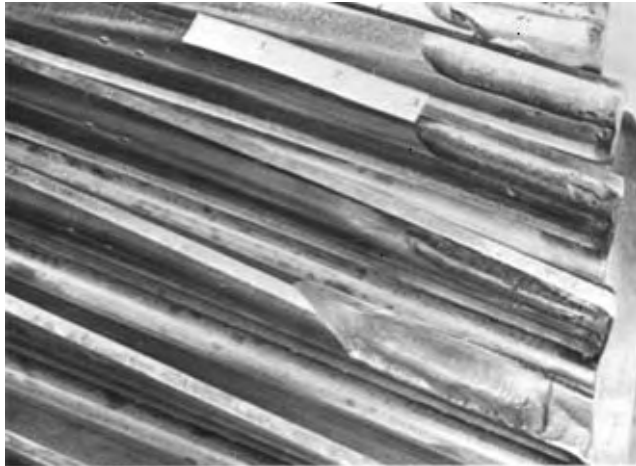


FIG. 2.33 (2342-14C) SURFACE BUMPS

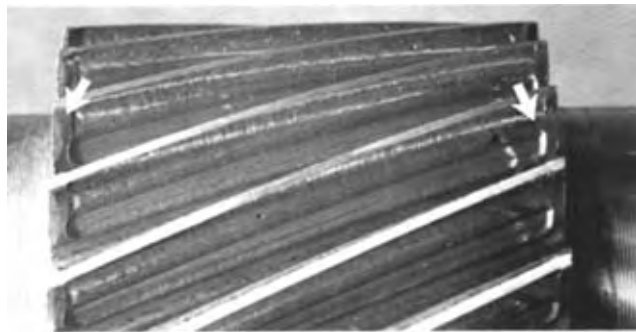


FIG. 2.34 (2342-15C) WEAR PADS

**FURROWING** has been observed on the working tooth surfaces of coarse textured, low DP, “as hobbed” mill pinion teeth shortly after being put into service. To the unaided eye, it appears as a lattice of fine hair lines oriented generally in the root-to-tip direction. They are aligned in rows across the face of the tooth in an order consistent with the hobbing texture pattern, see **Figure 2.35**.



FIG. 2.35 (2342-16C) FURROWING

The cause of furrowing has not been definitely established. Under the microscope, they appear as round bottom channels looking as if they were formed by hydraulic erosion. At present there are no recognized problems emanating from furrowing. It is thought to be prevented by minimizing localized contact pressure and by maintaining adequate lube films.

## PLASTIC FLOW

Plastic flow is the cold working of the tooth surfaces, caused by high contact stresses and the rolling and sliding action of the mesh. It is a surface deformation resulting from the yielding of the surface and subsurface material, and is usually associated with the softer gear materials, although it can occur in heavily loaded case-hardened gears as well.

**COLD FLOW** occurs when the surface and subsurface material show evidence of metal flow. Often surface material has been worked over the tips and ends of the gear teeth, giving a finned appearance. See **Figure 2.36**. This is sometimes called **ROLLING** or **WIRE EDGING**. Sometimes the tooth tips are heavily rounded-over and a depression appears on the contacting tooth surface. **PEENING**, another form of plastic flow as shown in **Figure 2.37**, is caused by excessive loading due to impact loading.



FIG. 2.36 (683-6) PLASTIC FLOW (ROLLING)

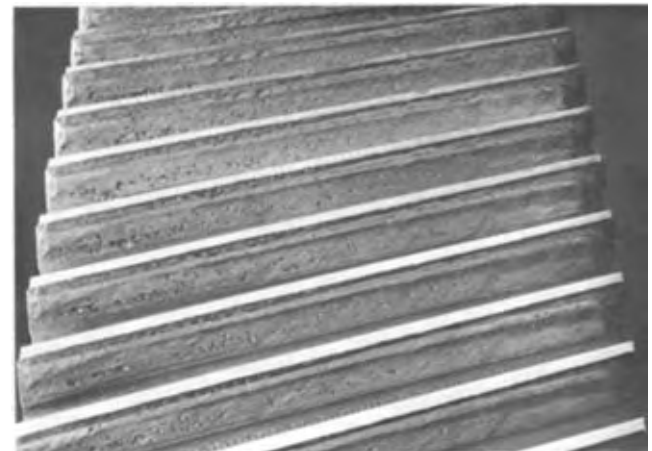
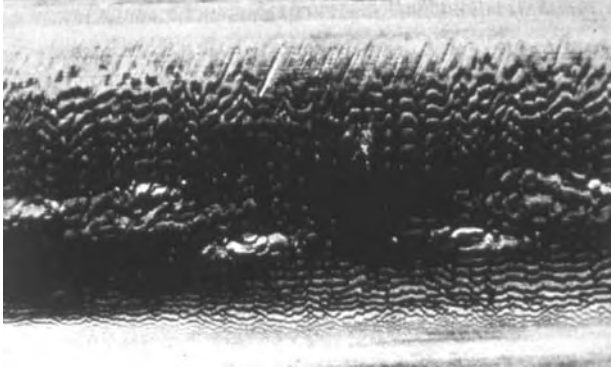


FIG. 2.37 (683-11) PLASTIC FLOW (PEENING)

Under heavy load, the rolling and peening action of the mesh cold-works the surface and subsurface material. The sliding action tends to push or pull the material in the direction of sliding, if the contact stresses are high enough. The dents and battered appearance of the surface are a result of dynamic loading due to operation while the profile is in the process of deteriorating from a combination of cold-working and wear. Failures of this type can be eliminated by reducing the contact stress and by increasing the hardness of the contacting surface and subsurface material. Increasing the accuracy of tooth-to-tooth spacing and reducing profile deviations will give better tooth action and reduce dynamic loads. If the high-

contact stress is caused by mounting deflections or helix-angle error, these conditions should be corrected.

RIPPLING is a periodic wave-like formation at right angles to the direction of sliding or motion, **Figure 2.38**. It has a fish-scale appearance and is usually observed on surface hardened gear surfaces, although it can occur on softer tooth surfaces under certain conditions. Rippling is not always considered a surface failure, unless it has progressed to an advanced stage.

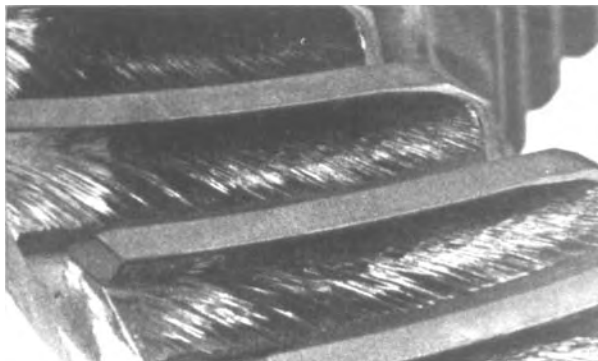


**FIG. 2.38 (2342-17C) RIPPLING**

High contact stresses under cyclic operation tend to roll and knead the surface causing the immediate surface material to ripple. This type of failure is usually associated with slow speed operation and an inadequate oil film thickness. The combination of high contact stress, repeated cycles, and an inadequate lubricating film will produce a rippled surface. Although rippling can be produced as a wear phenomenon, it most often is associated with a considerable amount of plastic flow.

If the gear material is soft, rippling can be prevented by case-hardening the tooth surface. Also, reduction in contact stress will reduce the tendency of the surface to ripple. Since the lubricating film is marginal, an extreme-pressure additive in the oil and an increase in oil viscosity may be beneficial. An increase in rubbing speed is sometimes helpful.

RIDGING is the formation of deep ridges by either wear or plastic flow of surface and subsurface material, **Figure 2.39**. It shows definite peaks and valleys or ridges across the tooth surface in the direction of sliding. Ridging is caused by wear or plastic flow of surface and subsurface material due to high contact compressive stresses and low sliding velocities. It is often present on heavily loaded worm and worm gear



**FIG. 2.39 (2342-18C) RIDGING**

drives and on hypoid pinion and gear drives. Ridging may occur on low-hardness materials and may also occur in high-hardness materials if the contact stresses are high, such as in case-hardened hypoid gear sets.

Ridging can be prevented by reducing the contact stress, increasing the hardness of the material, and using a more viscous lubrication oil with extreme pressure additives. In drives that do not have circulating systems, it is also helpful to change the oil often and to ensure that no foreign particles remain in the lubricant.

## BREAKAGE

Breakage is the ultimate type of gear failure. Bending loads on gear teeth usually cause the highest stresses at the root fillets and at the tooth profile/root fillet junctions. A gear tooth is a cantilever plate with tensile stresses on the contact side of the tooth and compressive stresses on the opposite side. If the tensile stresses at the critical location are allowed to exceed the endurance strength of the tooth material, fatigue cracks will eventually develop and with continued operation, will ultimately progress to the point where the tooth will break away from the rim material.

CLASSICAL TOOTH ROOT FILLET FATIGUE FRACTURE is the most common fatigue breakage mode. It is illustrated in **Figure 2.40**. The crack originates at the root fillet on the tensile side of the tooth and slowly progress to complete fracture either along or across the tooth. The face of these fractures are usually characterized by a series of contour lines or "beach marks" caused by the progressing crack "front". They indicate the position of the advancing crack front at a given time. As the section gradually weakens, the crack progresses further with each load cycle and the beach marks become more coarse. The focal point of these marks often locates the origin of the fracture.



**FIG. 2.40 (683-5) TOOTH FRACTURE (ROOT FILLET FATIGUE)**

Fatigue fractures result from repeated bending stress above the endurance limit of the material. If the tooth contact pattern appears even across the entire face, system overloads would be suspect. If the contact pattern is confined or "heavy" in the region of the fracture and at one end of the tooth, an alignment problem of the gearing would be suspect. When contact is good, system load must be reduced, or increased strength rating of the gearing is needed. If contacts indicate localized loading, gear alignment or face modifications should be examined.



LOW CYCLE FATIGUE OR IMPACT FRACTURES are due to a low number of high load fatigue cycles or to a single very high load. **Figure 2.41** illustrates such fractures. With lower hardness, more ductile materials, the fracture face is coarse, fibrous and torn in appearance. With harder, less ductile material, the appearance may be smooth or silky looking.

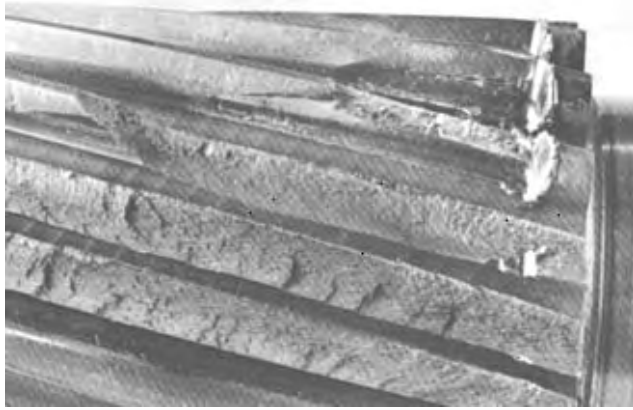


FIG. 2.41 (683-7) TOOTH FRACTURE (LOW CYCLE FATIGUE)

In some cases, a single overload may break out a tooth or several teeth. A more common occurrence is the plastic yielding of a group of teeth in one load zone from a high impact load. The plastic yielding displaces the pitch on this group of teeth with respect to the other teeth on the gears, thus subjecting them to abnormally high dynamic loads in subsequent operation. These teeth then develop very rapidly progressing fatigue cracks which soon lead to tooth breakage.

This type failure is prevented by protecting the gearing from high impact or transient loadings. This may involve the use of controlled torque or resilient couplings in the connected drive train or it may require better control by the customer at the process being performed by the driven equipment.

PIT ASSOCIATED FRACTURES occasionally originate in severely pitted areas since pits can act as stress raisers and can be crack origins. **Figure 2.42** illustrated such a fracture.

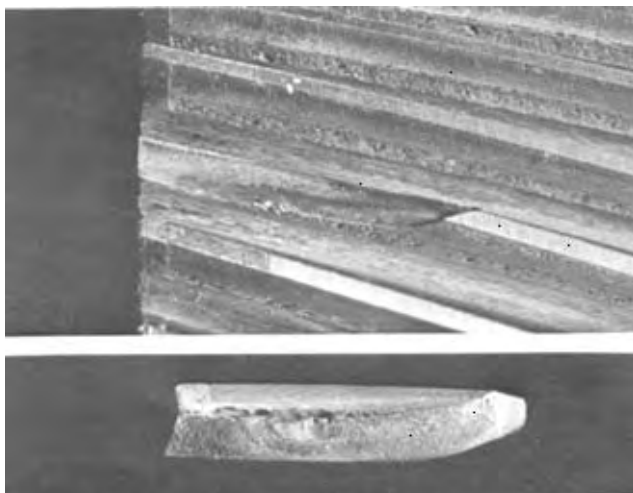


FIG. 2.42 (697-9) FATIGUE FRACTURE EMANATING FROM PIT

TOOTH TIP CHIPPING is a fracture mode where the top of a tooth will break away from lower portion, see **Figures 2.43 and 2.44**. Failures of this kind may be caused by deficiencies in the gear tooth, which results in a high stress concentration at a particular area. Sometimes flaws or minute grinding cracks will propagate under repeated stress cycling and a fracture will eventually develop. Foreign material passing through the gear mesh will also produce short-cycle failure of a small portion of a tooth. High residual stresses due to improper heat treatment can cause local fractures that do not originate in the tooth root section.

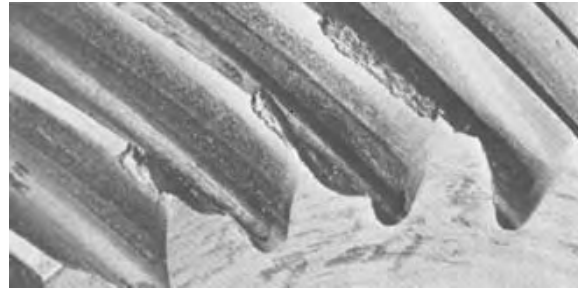


FIG. 2.43 (2342-19C) TIP CHIPPING (THRU HARDENED GEAR)

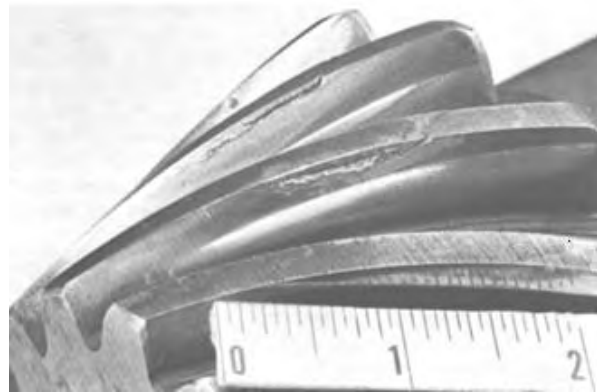


FIG. 2.44 (2342-20C) TIP CHIPPING (SURFACE HARDENED GEAR)

It is difficult to prevent failures of this type except by good design and manufacturing practices. If trouble is encountered, the gear surfaces should be checked for possible previous damage that may have contributed to local stress risers. The history of heat treatment and manufacturing techniques should be reviewed to ensure that proper processing was carried out during all steps of the manufacturing cycle. Cleanliness of the gear material should also be examined.

WORM WHEEL FRACTURES are occasionally encountered. **Figure 2.45** shows a tooth root fracture on a bolt-on type worm wheel. Such failures are rare and are indicative of overloading.

FRACTURE DUE TO FAILURE OF ASSOCIATED PARTS. Sometimes a severe load maldistribution of load on gear teeth can occur from damage to associated parts. **Figure 2.46** illustrates a pinion run for a time after a severe bearing failure. Load shifted to one end of the teeth and they subsequently broke away. The process repeated itself two more times before the element was finally removed from service. Similar fractures could occur from shaft that is severely bent or broken.





FIG. 2.45 (2342-21C) WORM WHEEL TOOTH FRACTURE



FIG. 2.46 (683-14) TOOTH FRACTURE FROM BEARING FAILURE

**FAILURES ASSOCIATED WITH PROCESSING**

QUENCHING CRACKS can develop with some materials during heat treatment and after quenching of the gear blank in a quenching medium. Often these cracks are visible to the naked eye, **Figure 2.47**. They may run across the top land of the tooth or be radial in direction at the ends of the teeth. When these are found, the material and heat treat specifications should be reviewed and the processing procedures reexamined.



FIG. 2.47 (2342-22C) QUENCH CRACKS (THRU HARDENED MATERIAL)

GRINDING CRACKS may form on the gear tooth surfaces due to process grinding, **Figures 2.48 and 2.49**. These surface cracks are usually in a definite pattern or network and often have the appearance of a series of short cracks laying parallel to each other. Grinding cracks may also have the appearance of a chicken wire mesh. The cause may be excessive grinding pressures or may be a metallurgical structure which is prone to cracking.

Sometimes grinding cracks are latent and do not show up until after several hours of shelf life or after operation under load.

When found an examination of the processing procedures is in order.



FIG. 2.48 (2342-23C) GRINDING CRACKS (ENLARGED)

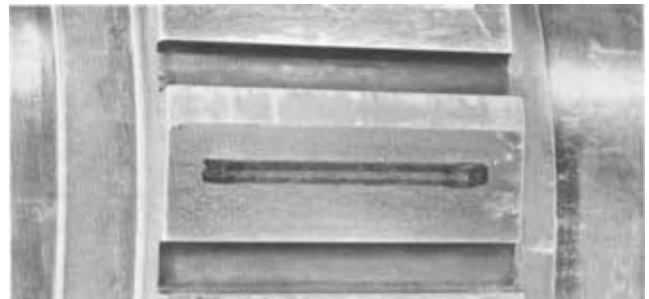


FIG. 2.49 (2342-24C) GRINDING CRACKS

**SUMMARY**

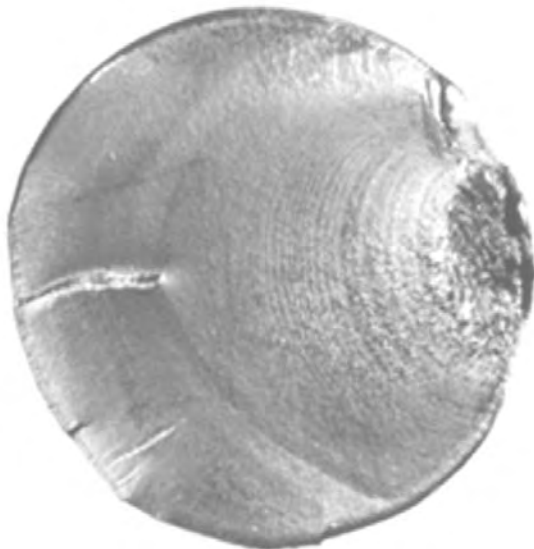
In this section, many of the distress and failure modes encountered with today's industrial gearing have been described. The various modes, however, have been treated as separate entities whereas in actual situations, several modes are often found together and the reader is advised that the determination for actual causes may require experienced experts who are familiar with the subtleties of the gear drive design and with the load characteristics of the particular application. The information does, though, provide some understanding and nomenclature useful in communicating information regarding specific problems.

### 3 - SHAFT DISTRESS AND FAILURE MODES

The performance of a gear set is dependent on the shafting for the gear elements. The shafting must be rigid enough to prevent excessive deflection that would result in abnormal load distribution on the gear teeth. The fits between the shafts and the bearings and between the shaft and the mounted gears must be proper so that mounted members are not too loose nor too tight as either condition can contribute to shaft failure. The shafts must be strong enough to resist permanent yield from shock loads and they must be strong enough to resist the reverse bending fatigue loads that are superimposed on the transmitted torsional loads.

In many cases a careful inspection of the shaft surface and the face of the fracture will reveal clues as to the probable cause of failure. When the clues are not obvious, it is helpful to know the function of the shaft in the drive system and to know the type of service in order to assess the primary cause of fracture.

In general, fractures resulting from bending stresses are perpendicular to the shaft axis, see **Figure 3.1**, whereas fracture resulting from fatigue type torsional stresses most frequently are disposed at a 45° angle to the shaft axis, see **Figure 3.2**.



**FIG. 3.1 (2342-25C) BENDING FRACTURE**

The most common type of shaft fracture encountered with gear drives is that resulting from the alternating bending stress that occur as the shaft rotates while transmitting a unidirectional torque load. The fatigue cracks almost always start at some stress raiser on the shaft such as sharp cornered fillets, snap ring grooves, fit corners, fretted areas, key or keyway ends, or tool or stamp marks.

**SYMMETRICAL STRESS RAISERS.** In cases where the fracture is caused by a stress riser that is symmetrical to the axis of the shaft, several things can be learned about the loading and the severity of the stress raiser. If the shaft is subjected to a low nominal stress, the crack usually starts from a single source and the final fracture area progresses from the surface

towards the center of the shaft. If the shaft is subject to high nominal stresses, many crack origins are found at the surface and the final fracture area is also near the shaft center.

The fracture face sometimes reveals the direction of rotation by noting the location of the final fracture area with respect to crack origin. The final fracture area is offset from the crack origin in the direction opposed to the shaft rotation.



**FIG. 3.2 (2342-26C) TORSIONAL FRACTURE**

**Figure 3.3** illustrates three types of shaft fractures. The one on the left resulted from bending fatigue due to a high stress raiser at a fillet. Note the many ratchet marks around the periphery at the fillet location indicating multiple crack starts. The fracture of the center shaft was due to bending fatigue, essentially having started at one location and propagating to shaft center when final fracture occurred. The fracture of the shaft shown on the right was primarily due to torsional fatigue originating at the left of the keyway. This crack propagated in the counterclockwise direction, but final fracture, to the right of the keyway was caused by bending. The small area of the final fracture zone indicates that the nominal stress was low.

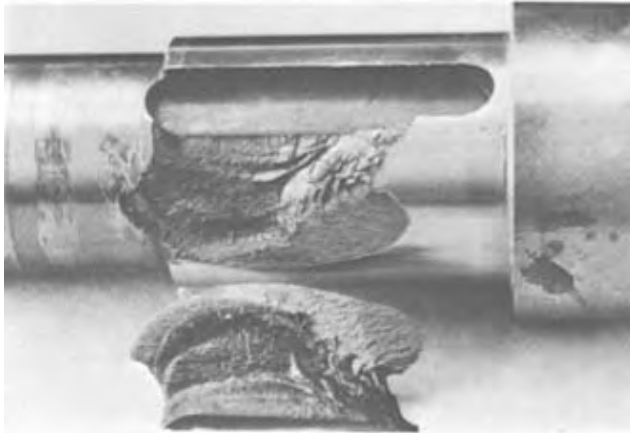


**FIG. 3.3 (548-7) SHAFT FRACTURES**

**KEYS AND KEYWAYS.** Some fatigue fractures start from a combination of stress raisers such as a keyway and the end of a key. **Figure 3.4** shows such a failure. The strength of a keyed joint is affected by the distribution of the load along the keyway. The strength of the shaft at the keyway depends on position of the key in the hub, the accuracy of the key and the keyway, the geometric shape of the end of the keyway and the location relative to shaft shoulder fillets and the magnitude of the interference fit.



**FIG. 3.4 (548-1) SHAFT FRACTURE (KEY AND KEYWAY ASSOCIATED)**



**FIG. 3.5 (548-6) SHAFT FAILURE (PEELING)**

A keyway fracture can be normal to the shaft axis as shown in **Figure 3.4** or it can peel circumferentially as shown in **Figure 3.5**. This latter type fracture occurs in a loosely fitted joint where nearly all the torque is transmitted through the key. Fatigue starts in the bottom of the keyway and progresses around the shaft axis.

**TORSIONAL FAILURES.** Gear drive shafting failures are seldom due to pure torsion. However, when they do occur marked characteristics are exhibited. Torsional cracks may follow transverse or longitudinal shear planes, or they may follow diagonal planes of maximum tensile stress and various combinations of these modes are possible. For this reason torsional fractures are more complex to analyze than bending fractures. Fracture due to a single overload in a ductile material may develop along the longitudinal shear plane, but in a brittle material the crack may develop on a 45° spiral angle perpendicular to the principal tensile stress. Torsional fatigue cracks may grow because of shear or tensile stresses or both.

**Figure 3.6** shows a torsional fatigue failure originating at the keyway and progressing as a result of a reversing torque in the system due to dynamic effects. The final fracture zone is typical of a torsional failure occurring along a plane approximately 45° to the axis of the shaft.

**FRETTING CORROSION** occurs where minute relative movement of tightly fitted parts occurs such as at bearing, gear and coupling hub seats. As fretting progresses, minute cracks form at the surface of the shaft which form stress raisers which can become origins for fatigue cracks. **Figure 3.7** illustrates such a situation. Fits must be designed properly and manufactured accurately to assure proper fit pressure to prevent fretting. On taper bore fits, locknuts which hold the gear in place must be properly torqued.



**FIG. 3.6 (548-5) SHAFT FRACTURES**



**FIG. 3.7 (2342-27C) FRETTING CORROSION**

**SUMMARY**

The successful operation of a shaft can be hampered by the creation of unexpected stress raisers formed in the processing of a shaft or during the operation of the gear drive. There may be other situations where an unexpected dynamic load may be imposed on the shaft which may be two to three times greater than the operating load. Situations sometimes occur where causes for a shaft failure cannot be determined, however it is expected that experience gained by Falk and others will, in time, offer better insights into such cases.



#### 4 - ANTI-FRICTION BEARING FAILURES

The selection of bearings is usually based on a specified bearing life under specific conditions of load. The life is based on the fatigue resistance of the contacting surfaces. However, experience indicates that 80% of installed anti-friction bearings fail to attain their expected service life. Most bearings fail at an early age for one or more of the following reasons.

- 1 - corrosion
- 2 - contamination of the lubricant
- 3 - overheating
- 4 - inadequate internal clearance
- 5 - unexpected vibratory loads
- 6 - misalignment
- 7 - inadequate lubrication

There are excellent publications printed by bearing manufacturers (1) (2) (3) (4) (5)\* that illustrate the more common failures. However, no matter how many pictures of failures are in existence, it seems that the failure in hand never quite matches, hence the purpose of this section of the Falk failure paper is to supplement existing illustrations with failures encountered by Falk.

#### CORROSION

A bearing can be failed before it is placed into service, if the unit in which it is mounted is improperly stored prior to installation. The damage done to a bearing due to corrosion manifests itself by a surface that appears to be stained. Under magnification, this area contains a series of pits which serve as a nucleus for a spall which leads to a complete failure shortly after the unit is placed in service. **Figure 4.1** which is the race of a large thrust bearing illustrates this type of failure. If a spalled bearing race is not excessively damaged, it is possible to get a clue as to whether corrosion was the basic cause by noting if the spalled areas are spaced approximately the same as the roller spacing. In **Figure 4.1** note the definition of the roller spacing.



FIG. 4.1 (2342-28C) FAILURE INDUCED BY CORROSION

#### CONTAMINANTS IN LUBRICANT

Solid contaminants in the lubricant can produce a denting of the rollers, balls, or races of a bearing. These dents then

become a stress raiser from which a pit will be formed. See **Figure 4.2**.

On some occasions the contaminant in the oil may be very fine and the oil will have the appearance of silver paint and the races will experience a lapping severe enough to increase the bearing clearance by .010 to .020". Under these conditions the shafts will become misaligned and the bearing cages may break.

The presence of water in the lubricant is not uncommon. The oil companies indicate that most industrial oils will contain dissolved water in the range of 50 to 500 parts per million (ppm). Research data indicates that water accelerated fatigue takes place when water concentration exceeds 100 ppm which can reduce bearing life from 30 to 80%. (6) (7)

The effects of contaminants can be minimized by either preventing the ingress of the contaminant, or by changing oil at the recommended change intervals.



FIG. 4.2 (2342-29C) DEBRIS DENTING

#### OVERHEATING AND INTERNAL CLEARANCES

Periodically, on start up, bearings have been reported to run hot. The overheating can be caused by insufficient internal clearance or insufficient lubrication. Insufficient clearance is usually the cause. There have been instances where the thermal expansion of the bearing elements is greater than the internal clearances and the bearings will load themselves and the heat will become intense enough to weld the rollers to the races as shown in **Figure 4.3**.



FIG. 4.3 (2342-30C) WELDING OF ROLLERS

\* Numbers in parentheses designate references on page 20.



If a ball bearing has run for a period of time with insufficient internal clearance, there could be a wear band or a series of bands on the ball as shown in **Figure 4.4**.



**FIG. 4.4 (2342-31 C) BALL BANDING**

**CAGE BREAKAGE-VIBRATORY LOADS MISALIGNMENT**

Bearing cages guide the rollers or balls in a bearing. They are usually lightly loaded. However, when a bearing is severely misaligned or when it is subjected to a vibratory load, or when the bearing is lightly loaded, the cage can be heavily loaded. The loads are caused by either the impact forces between the cage and the rollers, or the forces generated when the balls or rollers attempt to move out of their prescribed position. Lightly loaded rollers tend to skew and assume a position approximately 90° to their operating position.

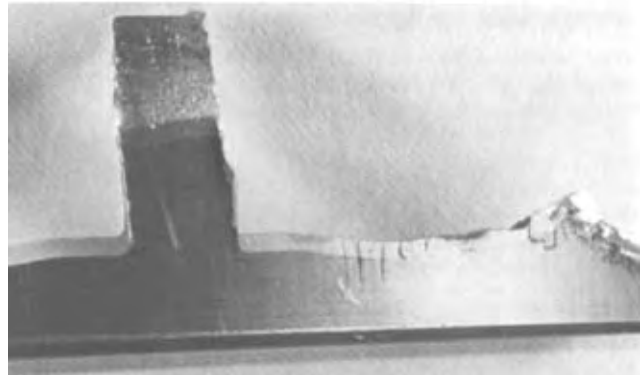
These loads can cause the cage to break as shown in **Figure 4.5**. If there are stress raisers present either from the processing of the cage or from the geometry of the part, the cage will break at these stress raisers. **Figure 4.6** illustrates the effect that a notch and a reduced section can have on the cage strength and **Figure 4.7** illustrates the cracks present at a sharp edge that was not removed after machining. In either case the result is the same, a failed bearing.



**FIG. 4.5 (2342-32C) CAGE BREAKAGE**



**FIG. 4.6 (2342-33C) CAGE BREAKAGE AT NOTCH AND REDUCED SECTION**



**FIG. 4.7 (2342-34C) CRACKS IN CAGE FROM NOT REMOVING SHARP EDGE**



**FIG. 4.8 (2342-35C) CAGE WEAR AND ROLLER END WEAR**

**INADEQUATE LUBRICATION**

Inadequate lubrication is defined today as either a lack of lubricant or the inability of the bearing to form an adequate film thickness. Lubrication damage is characterized by damaged roller ends and cages. The damage usually manifests itself as cage wear and wear on the roller ends. See **Figure 4.8**.

**SUMMARY**

The failures described here are only a few of the ways that a bearing can malfunction. If a bearing is properly installed and maintained and operated under loads for which it was designed, the bearing should exceed its expected life.

## 5 - FAILURE OF CONTACT OIL SEALS

Contact oil seals are used in Falk products as shown in **Figure 5.1**. They are used singularly or in combination with another seal or sealing media such as grease. The oil seal functions by either preventing oil from leaking from an enclosed drive or by preventing the ingress of dirt. The seal consists of a synthetic component bonded to a steel casing. A spring maintains pressure on the lip. The seal will malfunction for one or more of the following reasons, all of which will be explored in this paper.

- 1 - Damage to seal in handling or mounting.
- 2 - Hardening and cracking due to heat or chemical attack.
- 3 - Improperly prepared or damaged shaft journal.

The shelf life of a seal is considered indefinite if stored in accordance with the seal manufacturer's recommendation. Rarely has a failure in a Falk product been traced to a deterioration caused by improper storage or storage for too long a period of time.

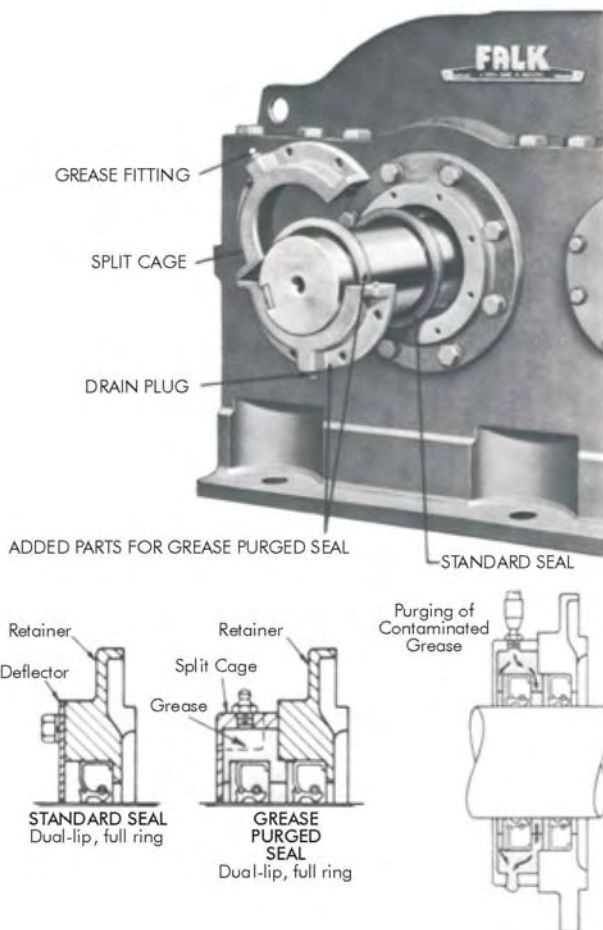


FIG. 5.1 (2342-36C) SEAL ARRANGEMENT

### CAUSES OF LEAKAGE

**CUT SEAL LIP.** In the handling and in the mounting of a contact seal, it is very possible to cut or nick the seal lip as it is slipped over a burr, keyway or spline. The use of proper mounting tools as defined by the seal manufacturer will prevent a cut lip. When a lip is cut, leakage is detected within several minutes after startup. A typical cut lip is shown in **Figure 5.2**.



FIG. 5.2 (2342-37C) CUT AND TURNED UNDER LIP

**TURNED-UNDER LIP.** In mounting a seal, the lip may turn under due to either an improperly designed or manufactured lead chamfer. The use of proper mounting tools and procedures will minimize the occurrence of a turned-under lip. **See Figure 5.2.**

**DAMAGED SPRING.** The spring which maintains pressure on the seal lip can become damaged or can "pop out" of the groove provided in the seal. This can occur during the handling and mounting of a seal, therefore it can be avoided by exercising care in handling and in mounting the seal.

**DAMAGED OR DISTORTED SEAL CASE.** A damaged seal case as shown in **Figure 5.3** can be encountered due to careless handling and mounting. Using care and the proper mounting tool will prevent this from occurring. A distorted seal case can be caused by a seal outside diameter too large for the bore.

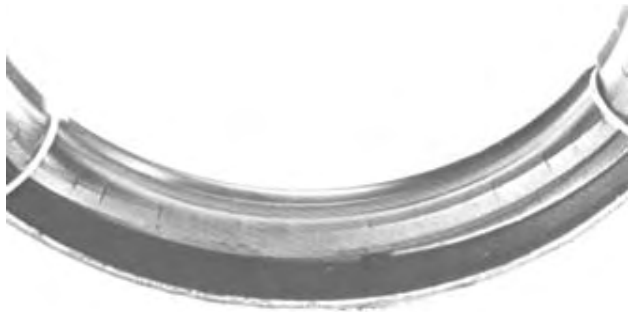
**SCORED OUTSIDE DIAMETER OF SEAL CAGE.** A seal with a scored outside diameter may leak around the O.D. This is usually caused from a burr or other machining imperfection in the housing bore that receives the seal.

**PAINT OR SEALANT ON SHAFT OR SEAL ELEMENT.** Paint or the sealant used on the outside diameter of the seal, deposited on either the shaft or seal lip, can contribute to leakage. This can be avoided by the proper masking of the seal and adjacent shaft before painting and exercising care in applying the sealant to the outside diameter of the seal.



FIG. 5.3 (2342-38C) DAMAGED SEAL CASE

**HARDENING AND CRACKING OF THE SEAL LIP.** Elastomers harden, crack and chip at the lip-shaft interface due to excessive heat, exposure to certain extreme pressure lubricants or exposure to chemicals. The cracking is shown in **Figure 5.4**. Chipping is shown in **Figure 5.5**. Laboratory tests have indicated that a Nitrile seal (most commonly used in a Falk drive) heated to 320° F will harden to the consistency of a phonograph record within 15 minutes. Another failure mode associated with heat is the formation of blisters on the sealing lip as shown in **Figure 5.6**.



**FIG. 5.4 (2342-39C) HEAT CRACKING**



**FIG. 5.5 (2342-40C) CHIPPING OF SEAL LIP**



**FIG. 5.6 (2342-41C) BLISTERS ON SEAL LIP**

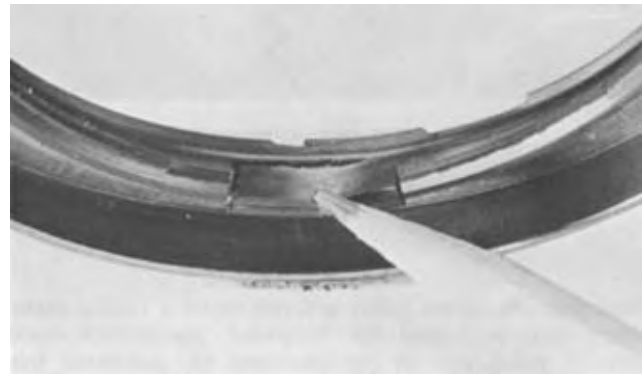
Published values indicate the following maximum service temperatures for various seal materials, however, nothing is stated regarding the expected seal life at these temperatures.

Material	Maximum Service Temperature
Natural Rubber	212°F
Chloroprene (Neoprene)	250
Nitrile	250
Silicone	550
Fluoroelastomers (Teflon, Viton, Nylon)	600

The availability of some seal materials is limited and prevents easy substitution. Before considering an alternate material, its availability should be checked and all its properties studied to determine suitability for the environment and application.

The chemical action of some EP lubricants will cause a seal to harden, the rate of hardening increases with temperature. The EP lubricants shown in Falk Service Manual 128-010 are compatible with Nitrile seals. Tests are conducted periodically at Falk by submerging an oil seal in a tank of lubricant maintained at 200° and inspecting the seal at frequent intervals to determine the effects of the lubricant on the seal material.

**ELEMENT CRACKING-NO HARDENING.** Tests conducted by Falk indicate that when Nitrile seals are exposed to an atmosphere of 9-11 parts per million (ppm) of ozone, they will exhibit radial and circumferential cracks without any evidence of hardening. These cracks are shown in **Figure 5.7**. When an atmosphere containing this amount of ozone is encountered, either the seal should be protected by another media such as grease, or the seal material should be changed.



**FIG. 5.7 (2342-42C) RADIAL AND CIRCUMFERENTIAL CRACKS DUE TO OZONE**

**EXCESSIVE LIP WEAR.** The width of the wear band of a normally wearing seal is .010-.030" depending on size of seal. If the band width is wide on one side and narrow diametrically opposite, it is possible that the shaft is misaligned to the bore. Initial leakage will generally occur in the area which shows little to no wear due to inadequate lip contact. As the worn side is hardened from excessive pressure and heat, it may crack and cause additional leakage.

**SHAFT JOURNAL.** Shaft journals used by Falk are plunge ground to a surface finish of 16 micro-inches (RMS). The hardness of the journal is the same hardness of the shaft. It has been Falk's experience that these specifications have worked well. The scratches are circumferential and have no lead. If a seal leaks in only one direction of rotation, it is possible that oil is passing along a scratch or a tool mark that has a lead.

The width of the seal path on a shaft should vary from .010" to .030" and be only a few thousandths deep. See

**Figure 5.8.** If the wear path is wider than .030" or deeper than what you can feel with your fingernail, leakage may be encountered. The causes of this condition can be abrasive conditions, eccentricity between seal and shaft, cocked seal or axial motion between seal and shaft. A shaft surface with this degree of wear will leak, hence should be resurfaced or the seal should be relocated along the shaft in order to provide a new shaft surface.

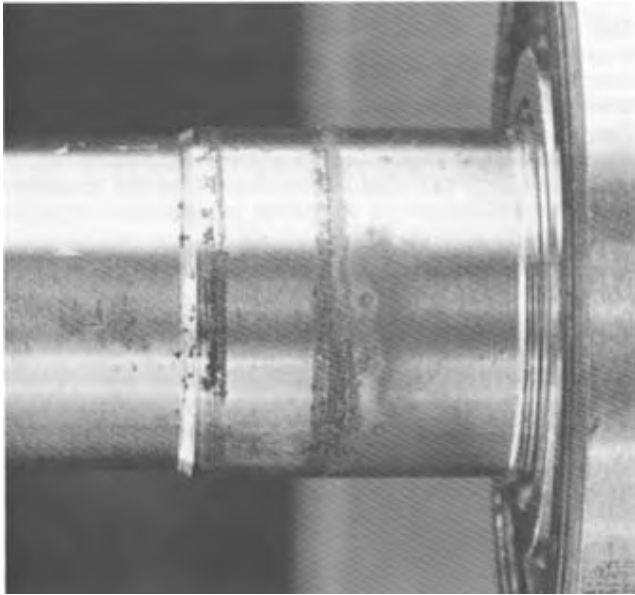


FIG. 5.8 (2342-43C) JOURNAL WEAR

## SEAL LIFE

Seal manufacturers today will not make a public statement regarding seal life. However, statements made several years ago in the literature (8) indicates that "long life" is considered to be more than 1000 hours before leakage results, that "medium life" is defined as leakage beginning at 400-600 hours of operation and that "short life" is 100 hours. In another paper (9) it is pointed out that a Nitrile material "withstands temperatures of 100-200E at surface speeds of 200 fpm for approximately 3000 hours. Viton would last longer possibly up to 10,000 hours. Information given to Falk in 1965 by Chicago Rawhide indicated that the seal life for a Nitrile seal at 200E was 3000 hours. Apparently their studies did not consider seal life at lower temperatures. A more recent paper (10) reveals data regarding seal tests where it is indicated that a criteria of success is to operate without leakage for a period of 100 to 500 hours, and that from a test of 10 seals they all leaked within 1100 hours. The following statement made in this paper can best summarize the performance of contact seals:

"All seals will leak if run long enough at a given set of conditions. Material, process, design and test variations will result in variations in time to leakage."

## SEAL LEAKAGE

Information regarding degree of leakage is impossible to obtain from seal manufacturers. The only definitive information uncovered (8) indicates that most synthetic seals (about 80%) leak .002 grams/hr. or approximately one drop every 11 hours. This is not considered to be troublesome by some persons. About 15% of synthetic seals leak .002-0.100 grams/hr. (approximately 1 drop per 11 hours to 1 drop per 11 minutes), a rate which is considered borderline. If the leakage rate is in excess of 0.10 grams/hour the seal can be considered defective, misapplied or misspecified.

## SUMMARY

Precise performance criteria for contact seals is impossible to obtain from seal manufacturers. The following statement is based on the years of experience that Falk has had with the application of contact oil seals in their products and must be regarded as a tentative standard by which to measure seal performance.

All contact type oil seals used in enclosed gear drives will leak if operated long enough. The variation in time before leakage occurs will depend on the material of the seal, the operating temperature of the gear drive and lubricant, the type of lubricant used, the quality of the seal-shaft surface interface and the environment in which the gear drive operates. A wetting of the surface may commence shortly after the startup of a gear drive and may then progress to the formation of droplets. Unusual operating conditions would accelerate the leakage.

## REFERENCES

- (1) "Analysis of Tapered Roller Bearing Damage", Widner and Wolfe, American Society for Metals, Report C-7-11.1, October 1967.
- (2) "How to Recognize and Prevent Tapered Roller Bearing Damage", The Timken Company, Canton, Ohio, 1970.
- (3) "Bearing Failures and Their Causes", SKF Industries, King of Prussia, Pa., 1968.
- (4) "Spherical Roller Bearing Service Damage and Causes", The Torrington Co., South Bend, Indiana, 1960.
- (5) "How to Prevent Ball Bearing Failures", the Fafnir Bearing Company, Form 493.
- (6) "Fatigue Prevention by Lubricant Chemistry", Mobil Oil Corporation Publication.
- (7) "The Effect of Water in Lubricating Oil on Bearing Fatigue Life", Richard Cantley, ASLE Paper 76-AM-713-1, May 1976.
- (8) 1973-1974 Seals Reference Issue - Machine Design, September 13, 1973, page 22, Penton Press, Cleveland, Ohio.
- (9) "The Fluoroelastomer Seal: A Stronger Link", Daniel B. Jackson, (Manager R & D, Parker Seal Company), Power Transmission Design, July 1971.
- (10) "Statistical Interpretation of Shaft Seal Performance", Leslie Horve, SAE Paper 741044, October 1974.